

Compression Load cells

TYPE: **C-82** 500kg, 1t - 2.5t - 5t -10 ton
C-100 15 ton

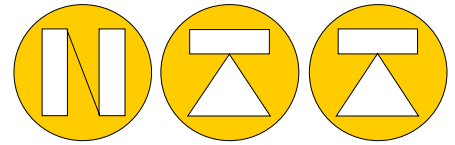

NORDIC TRANSDUCER



Compact size good accuracy compression series of load cells for usage under hostile environment as in hopper weighing systems for industry with demands for IP65 load cell protection.

Attractive price level compered with the overall quality of the load cells.

C-82 shown with Load head and base plate

C-82 & C-100 SPECIFICATIONS

NOMINAL LOAD C-82	500kg, 1t, 2,5t, 5t, 10ton	a) minimum load	0%
NOMINAL LOAD C-100	15ton	b) service load	100%
COMBINED ERROR	< +/- 0.05%	c) max. permissible load	120%
NON REPEATABILITY	< +/- 0.02%	d) breaking load	>300%
ZERO DRIFT 20MIN	< +/- 0.03%	e) max. side load	50%
TEMPERATURE EFFECT 10°C		f) max. dynamic load	50%
on zero	< +/- 0.02 %	PROTECTION CLASS	IP65
on span	< +/- 0.02 %	NOMINAL TEMP. RANGE	- 10/+40 °C
NOMINAL SENSITIVITY +/-0.005	2mV/Volt	SERVICE TEMP. RANGE	-20/+65 °C
INPUT RESISTANCE	750 Ohm	CELL MATERIAL	Stainless Steel
OUTPUT RESISTANCE	700 Ohm	CABLE	Ø5 x 6 meter
ZERO BALANCE	1.0%	Options:	Load head & base plates
SUPPLY VOLTAGE DC/AC	2V - 15 Volt		

All specifications subject to change without notice



NTT do also supply Indicators for all kind of jobs

Nordic Transducer Als Oddevej 85 DK-9560 Hadsund Danmark
 Ph. +45 98 58 14 44 fax. +45 98 58 18 66 e-mail: ntt@ntt.dk WEB: www.ntt.dk



Compression Load cells

TYPE: C-82 & C-100

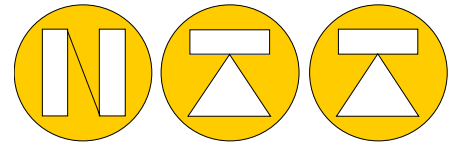

NORDIC TRANSDUCER

Dimensions in mm

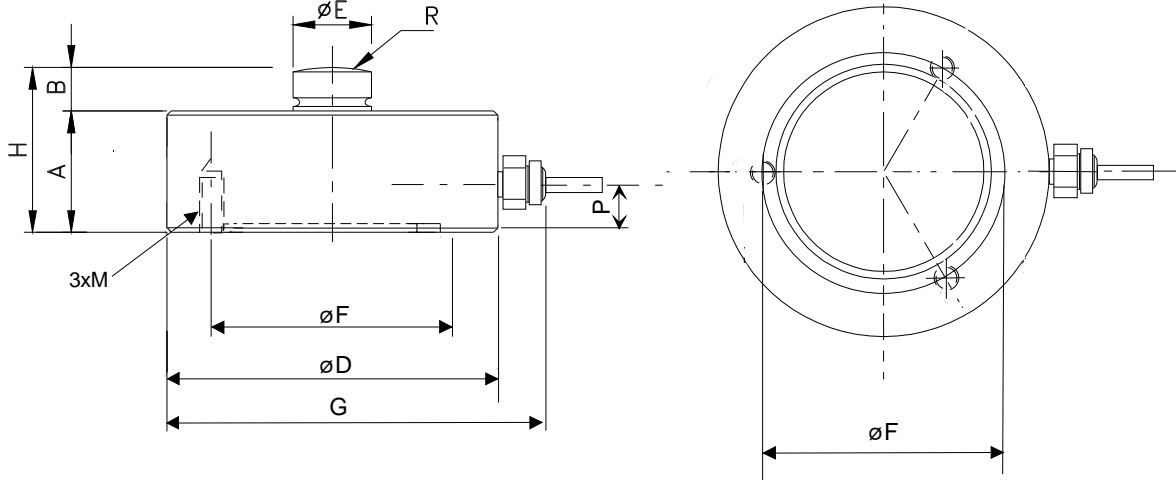

Cable color code

Red + Excitation
Green + signal
Black - Excitation
White - signal

Capacity ton	A	B	Ø D	Ø E	Ø F	G	H	M	R	P
500kg ..10 ton	31	13	82	22	68	99	44	M8	120	13
15 ton	35	13.5	100	28	80	117	48.5	M10	120	13

PB120-82 base plate for C-82

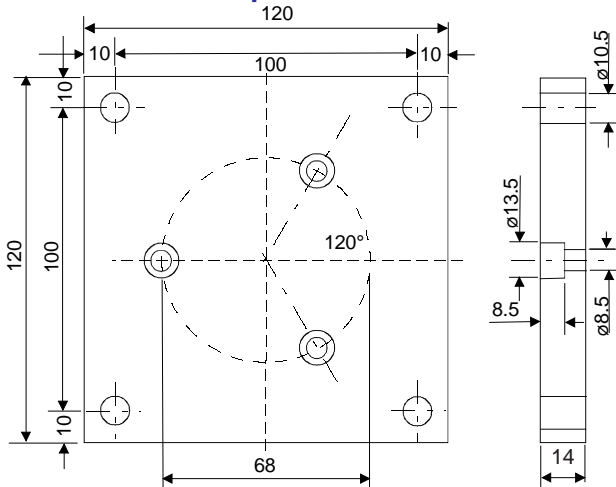

Load heads

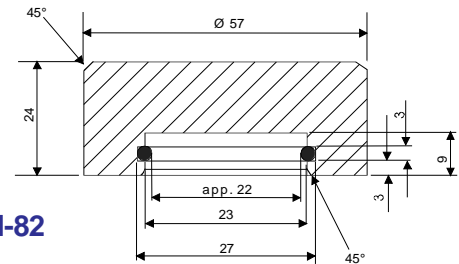

LH-82

PB120-82-SS
Produced in 304 Stainless steel

PB120-100 base plate for C-100

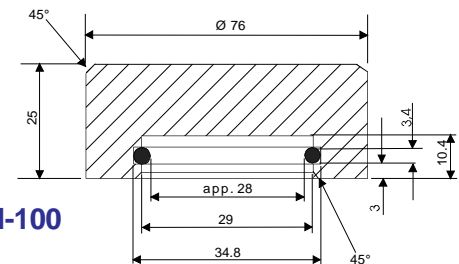
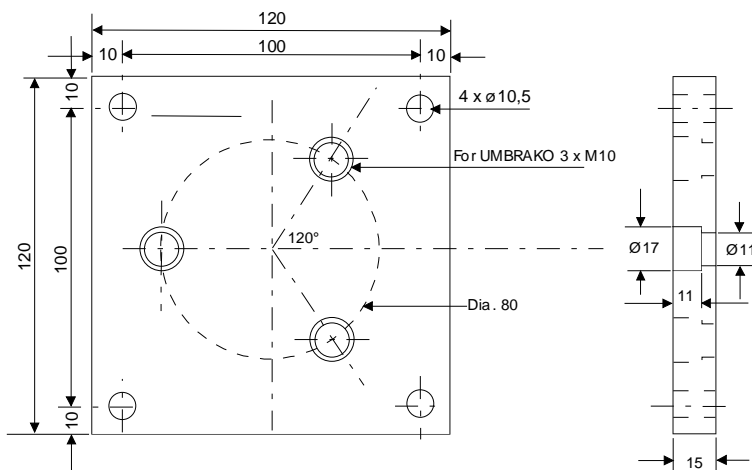

LH-100

PB120-100-SS
Produced in 304 Stainless steel

PB120-100-NS
Produced in high quality steel
nickel plated after all machining
has been done.